



# DucoBox Focus

ENGLISH **en**

Product version **17xxxx** and above

## Installation guide



  Video instructions  
[www.duco.tv](http://www.duco.tv)

## Table of contents

|   |           |
|---|-----------|
| <b>01 Introduction</b> .....                          | <b>3</b>  |
| <b>02 Mounting</b> .....                              | <b>4</b>  |
| 02.A Positioning.....                                 | 4         |
| 02.B Fixing.....                                      | 4         |
| 02.C Air duct connections.....                        | 4         |
| <b>03 Wiring</b> .....                                | <b>5</b>  |
| 03.A Connections & buttons.....                       | 5         |
| 03.B Wiring diagram.....                              | 5         |
| <b>04 Control valves</b> .....                        | <b>6</b>  |
| 04.A Mounting the control valves.....                 | 6         |
| 04.B Pairing the control valves.....                  | 7         |
| 04.C Removing / replacing control valves.....         | 7         |
| 04.D LED indications.....                             | 7         |
| <b>05 Additional control options</b> .....            | <b>8</b>  |
| 05.A Duco Connectivity Board.....                     | 8         |
| <b>06 Electronical installation</b> .....             | <b>9</b>  |
| 06.A Installer / User mode.....                       | 9         |
| 06.B LED indications DucoBox Focus.....               | 9         |
| 06.C Pairing components.....                          | 9         |
| 06.D Removing / replacing components.....             | 11        |
| 06.E Tips.....  | 11        |
| <b>07 Flow rate calibration</b> .....                 | <b>12</b> |
| 07.A Air calibration procedure for DucoBox Focus..... | 12        |
| 07.B Checking.....                                    | 13        |
| <b>08 Maintenance &amp; service</b> .....             | <b>14</b> |
| <b>09 Warranty</b> .....                              | <b>14</b> |
| <b>10 Legislation</b> .....                           | <b>15</b> |

### Translation of the original instructions

See [www.duco.eu](http://www.duco.eu) for information regarding warranty, maintenance, technical data, etc.

Installation, connection, maintenance and repairs are to be carried out by an accredited installer. The electronic components of this product may be live. Avoid contact with water.



# 01 Introduction

Congratulations on your DucoBox Focus, the smartest box in Europe! The DucoBox Focus performs two functions in a Duco Demand-Controlled Natural Ventilation System:

On the one hand it is the **extractor fan** that exhausts contaminated air with excessive CO<sub>2</sub> content or relative humidity. Thanks to integrated control valves, air is only exhausted in the zone that requires it.

On the other hand, it is the **master** or brain of the system. It receives and interprets signals from slave components (measurements from sensors or manual input), on the basis of which it controls the ventilation system.

It is inadvisable to connect the DucoBox (via a duct or directly) to an extractor hood, regardless of type. This usually causes excessive fouling in the DucoBox, which affects its operation or has a more direct effect on the flow rate.

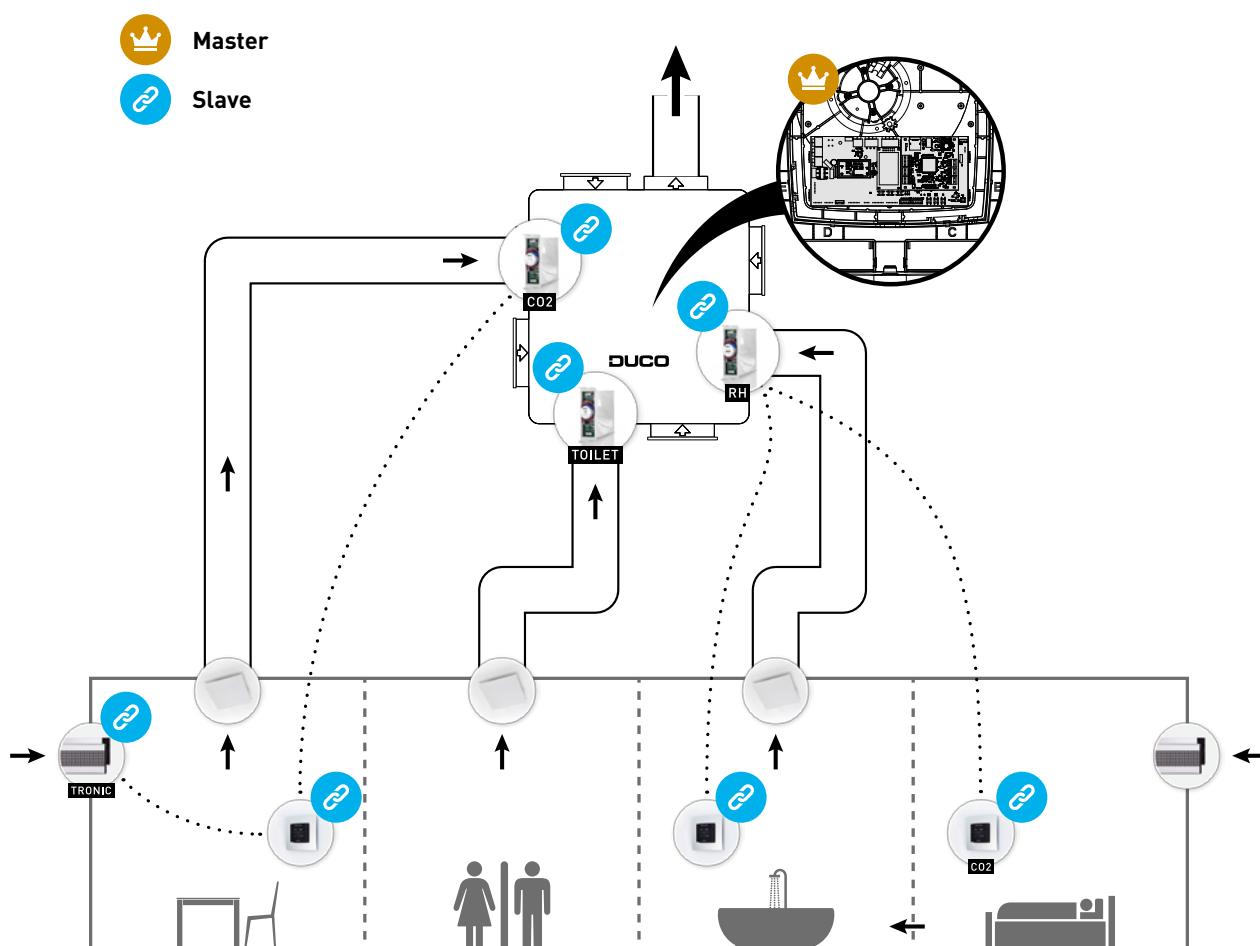

# 02 Mounting

## 02.A Positioning

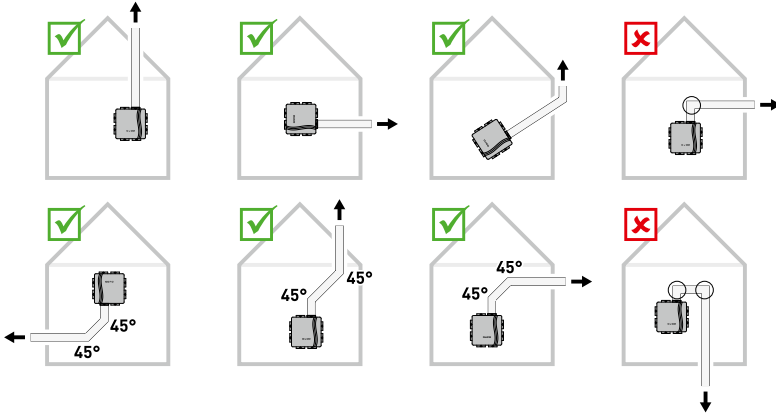

## 02.B Fixing

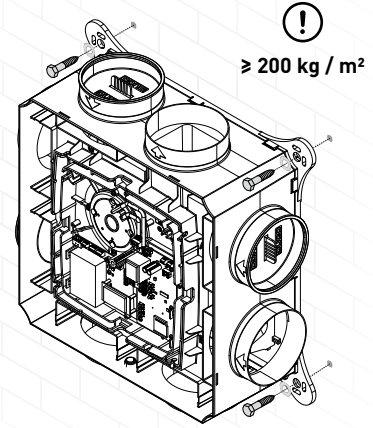

## 02.C Air duct connections

Limit the resistance. A non-return flap is required when discharging into a manifold. Position it at least 30 cm away from the DucoBox.

Be sure to take note of the '10 unmissable tips' as well when mounting the DucoBox. Avoiding excessive use of bends, especially angles sharper than 90° and adhering to the diameter guidelines for the ductwork will ensure that the ventilation box is able to do its job satisfactorily. Failure to take account of this recommendation may result in a highly energy and maintenance intensive system that gives rise to excessive noise nuisance frequently.

## 10 UNMISSABLE TIPS

The smooth running of your Duco ventilation system is totally dependent on the choice and the quality of implementation of the duct system!

Has the duct system been optimized? Ask professional advice from your duct supplier. It saves you time, ensures quality and provides energetic advantage for the end user!

DISCLAIMER: no rights can be derived from this document. All tips are only advisory. All those carrying out the work can, depending on the project at hand, determine for themselves which tips are feasible and/or useful.

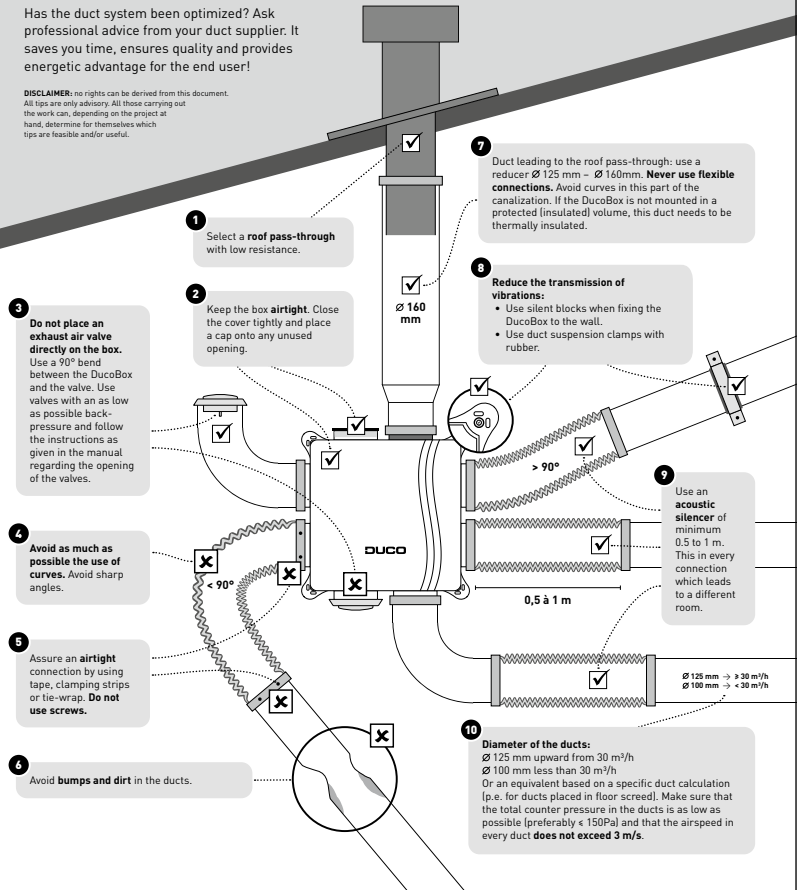

# 03 Wiring

## 03.A Connections & buttons

### Strain relief

It is mandatory to place the power supply cable in the slot provided, as shown in the drawing, before powering up the DucoBox.

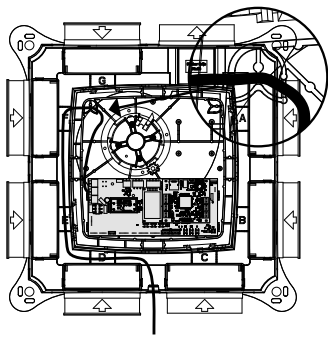

Illustrations and connections may vary depending on the version of the product. Incorrect connection or failure to follow the instructions may result in damage to the connected devices.

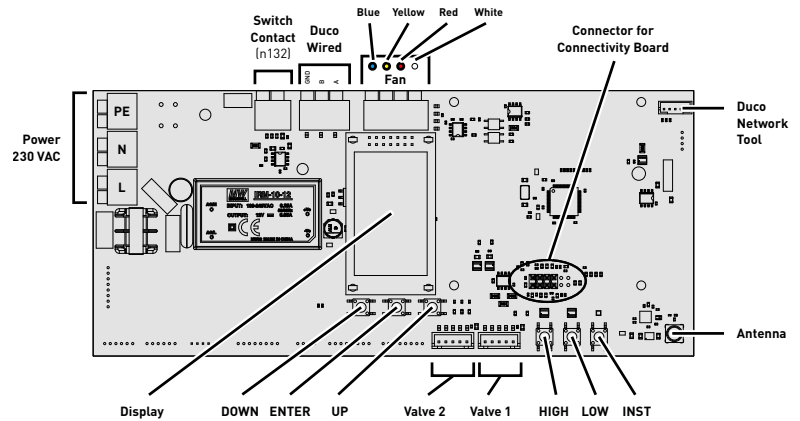

## 03.B Wiring diagram

The DucoBox Focus is able to communicate with Duco slave components via a wireless (RF) or wired link. Both types of communication can be combined in one system. Communication with non-DUCO components is possible via the switch sensor.

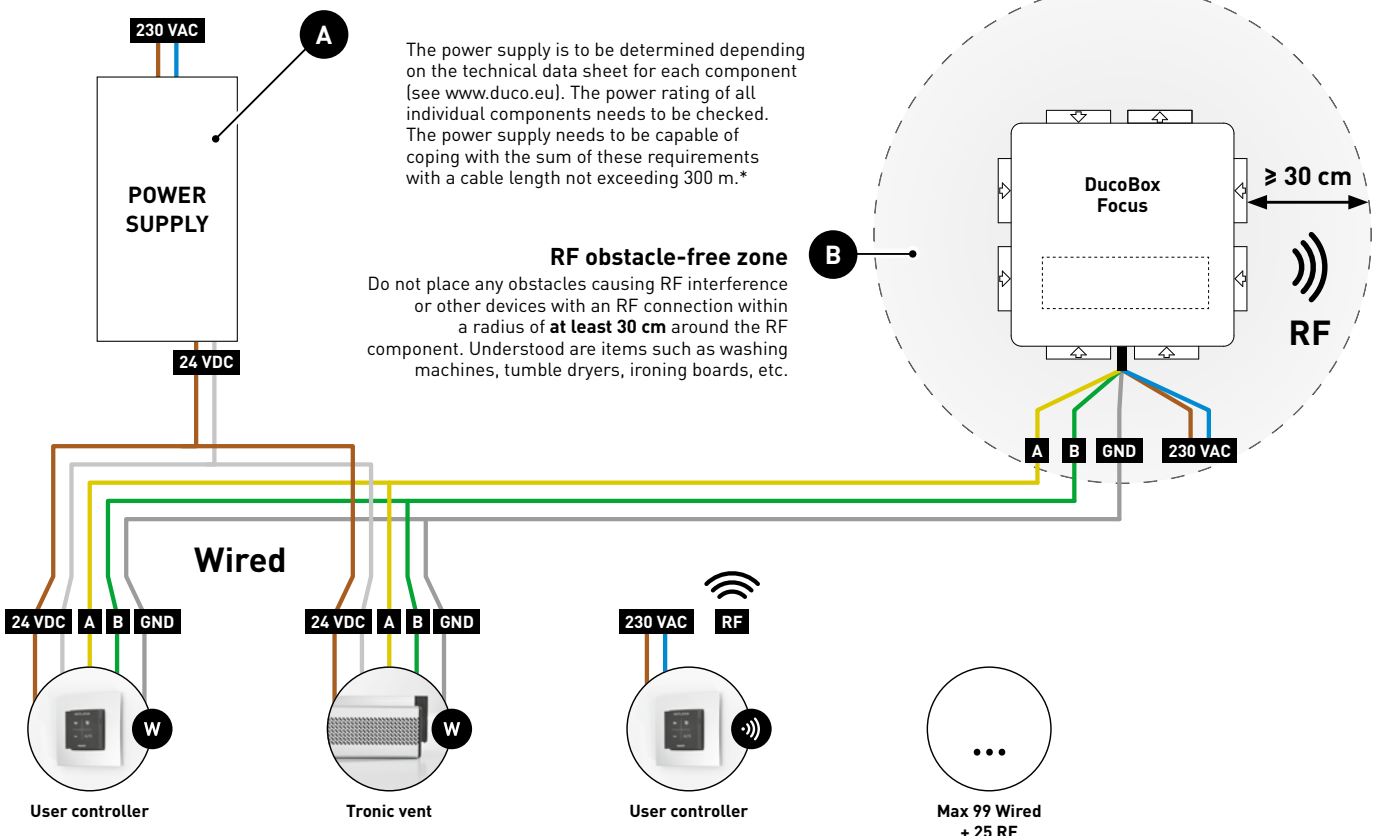

\* Use a screened solid-core cable not exceeding 300 m in length, with 5 cores 0.75 mm<sup>2</sup> each.

## RF (wireless communication)

**RF components** have a maximum free-field range of 350 metres. This distance will be much less in a building because of obstacles. Therefore, you will need to take objects such as walls, concrete and metal into account. All slave components (except those which are battery powered) also act as repeaters. Signals from components that are unable to make a (strong) connection with the master component are forwarded automatically via no more than one other non-battery-powered component (= hop). Please refer to information sheet **RF communication (L8000018)** at [www.duco.eu](http://www.duco.eu) for further information.

| DUCO RF                      |   |
|------------------------------|---|
| Power supply                 | 230 VAC   |
| Wiring                       | 1,5 mm <sup>2</sup>                             |
| Frequency                    | 868 Mhz   |
| Maximum distance             | 350 m, free field (less through obstacles)      |
| Maximum number of components | Up to 25 wireless components in a single system |

## Wired (cabled communication)

**Wired components** can be daisy-chained (= recommended). This means that a separate cable will not be required for each component. A single central power supply can be used.

The cable required is a 5 x 0.75 mm<sup>2</sup> data cable. We strongly advise using a shielded cable. This is to prevent any interference that may affect the data communication. Any Tronic window ventilators will be supplied with a 5 x 0.25 mm<sup>2</sup> cable which can be connected via a splicing terminal block.

| DUCO WIRED                   |   |
|------------------------------|---|
| Power supply                 | 24 VDC  |
| Wiring                       | 5 x 0,75 mm <sup>2</sup><br>(5 x 0.25 mm <sup>2</sup> from Tronic window ventilators) |
| Maximum distance             | up to 300 m   |
| Maximum number of components | Up to 99 wired components in a single system  |

# 04 Control valves

The control valves, whether or not they are fitted with a sensor for measuring CO or humidity, can be built into the DucoBox Focus. Together with the fan, they ensure the correct exhaust airflow rate in the right room.



**A control valve with combined CO<sub>2</sub> and RH measurement can only be used with a DucoBox Focus with a software version of 11.2 or higher.**

A DucoBox Focus can contain up to a maximum of 7 control valves (= one per supply duct). This can be expanded to a maximum of 11 control valves by using the 'Control Valve Manifold' (item 0000-4454).



**A control valve must always be provided for each ventilation duct connected!**

## 04.A Mounting the control valves

Slide the control valve into the locations provided in the DucoBox Focus. Connect the 'VALVE' connector on the DucoBox to **IN** on the control valve. If applicable, connect **OUT** on the valve to **IN** on another control valve to be added. At least one valve must be connected to the DucoBox at any time.

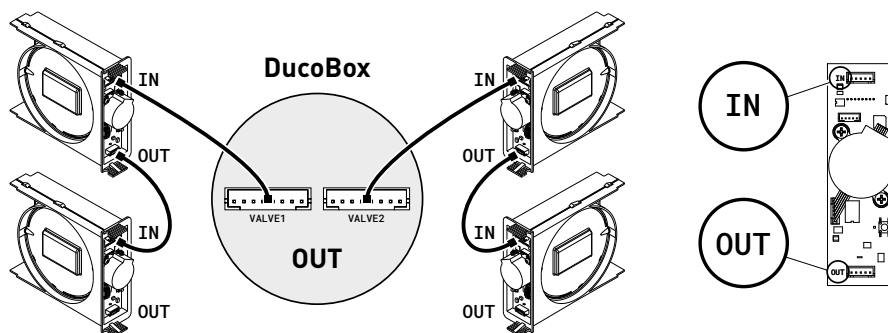

**TIP:** Use the letter labels on the DucoBox and the valves (A/B/C/D/E/F/G) to give these the same letter, so that the valves always remain in the same position.

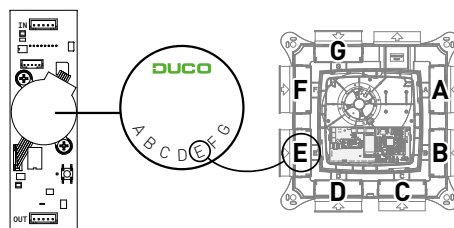

## 04.B Pairing the control valves

The control valves are paired automatically to the DucoBox whenever 'installer mode' is activated (see "Pairing components" chapter).

## 04.C Removing / replacing control valves

### Taking control valve out temporarily

Follow these steps to take a control valve out of the unit **temporarily**, e.g. to clean it during maintenance. Make sure that the control valve is inserted back in the same location. Use the letter labels on the DucoBox and the relevant valve for this. The DucoBox will retain all its settings when the control valve is reconnected.

#### Temporarily removing control valve

- 1 Briefly press the button on the valve to close it for 15 minutes. The LED will go out.
- 2 Disconnect the wiring.
- 3 Slide the valve out of the DucoBox.

### Permanently removing or replacing control valve

To remove a control valve permanently from the system or to replace it (e.g. in the event of a fault) it is important that it should be deregistered correctly. The DucoBox will not be able to be calibrated correctly if this is not done.

#### Permanently removing control valve

- 1 Briefly press the button on the valve to drive it shut.
- 2 Activate 'Installer mode' by pressing '**INST**' on the DucoBox. The LEDs on the DucoBox and control valves will flash green rapidly.
- 3 Long-press the button **once** on the control valve to be removed in order to remove it from the network. **ATTENTION: any underlying components will also be removed from the network.**
- 4 Disconnect the wiring from the control valve to be removed and slide it out of the DucoBox.
- 5 Deactivate 'Installer mode' by pressing '**INST**' on the DucoBox. All LEDs will stop flashing.

#### Replacing a control valve

- 1 Briefly press the button on the valve to drive it shut.
- 2 Activate 'Installer mode' by pressing '**INST**' on the DucoBox. The LEDs on the DucoBox and control valves will flash green rapidly.
- 3 Short-press the button **twice** on the control valve to be replaced in order to remove it from the network.
- 4 Disconnect the wiring from the control valve to be replaced and slide it out of the DucoBox.
- 5 Slide the new control valve into the DucoBox and connect it.
- 6 Short-press the button on the new control valve **once**. The latter will take on all settings / connections in the network.
- 7 Deactivate 'Installer mode' by pressing '**INST**' on the DucoBox. All LEDs will stop flashing.

## 04.D LED indications

In normal operation, the LED on the control valves will be white or off, depending on the control valve position. The brightness of the LED indicates the flow rate through the valve.

Please refer to "06.B LED indications on page 9 for the meaning of the remaining LED colours.

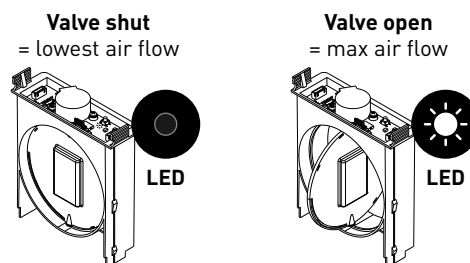

# 05 Additional control options

## 05.A Duco Connectivity Board

The optional circuit board allows linking towards home automation and building management systems via REST API (locally or via the cloud) or Modbus TCP (locally). Both are possible via Ethernet or Wi-Fi.

The Duco Connectivity Board also enables the Duco Installation App to be used. This application supports - and relieves - installers to control and maintain a ventilation system in a user-friendly way.

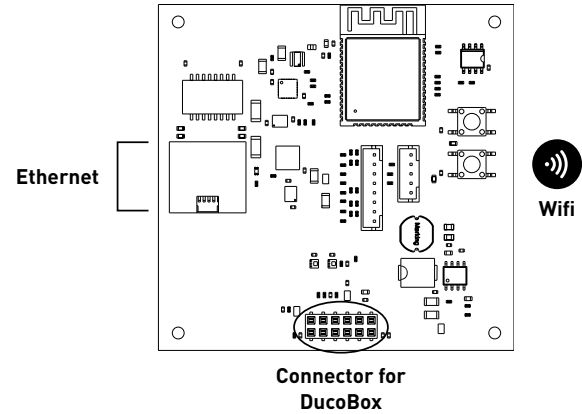









# 06 Electrical installation

## 06.A Installer / User mode

To add, remove or replace components to the network, the system should be put in 'Installer mode'. The LED on each component indicates the active mode of the component (see table in next section).

'Installer mode' can be activated by pressing the DucoBox Focus 'INST' button (see drawing in section "03.A Connections & buttons" on page 5. Once the LED on the master unit starts flashing, it means that 'Installer mode' is active. Press 'INST' again to return to 'User mode' (LED fully on or off). The system reverts automatically to 'User mode' after 15 minutes of inactivity.

## 06.B LED indications DucoBox Focus

|   |  |  |
|---|--|--|
|    | <b>RED (blinking slowly)</b><br>Not in network   | <b>RED (blinking rapidly)</b><br>Currently pairing                               |
|    | <b>GREEN (blinking slowly)</b><br>In network   | <b>GREEN (blinking rapidly)</b><br>In network, waiting for associated components |
|    | <b>YELLOW (blinking slowly)</b><br>Transitional phase (please wait)  | <b>YELLOW (on)</b><br>Initialising (system configuration in progress)            |
|   | <b>WHITE or OFF</b><br>Normal  |  |
|  | <b>BLUE</b><br>Component is displayed if changes are being put through via the master.   |  |
|  | <b>ORANGE</b><br>The system is not working correctly because the DucoBox has not been calibrated. Restart the DucoBox. Follow the guidelines in '10 essential tips' if the problem recurs continually. |  |

## 06.C Pairing components

The DucoBox Focus is an extractor fan for a **zonal ventilation system**. This means that ventilation will only operate in the zones where it is needed (e.g. only in the bathroom while showering) for the most energy-efficient operation. Thus, in the example below, pressing the button in zone 1 will change the ventilation setting only for this zone. Pressing the button on the master user control will command all zones that are set to 'AUTO' at that point in time.

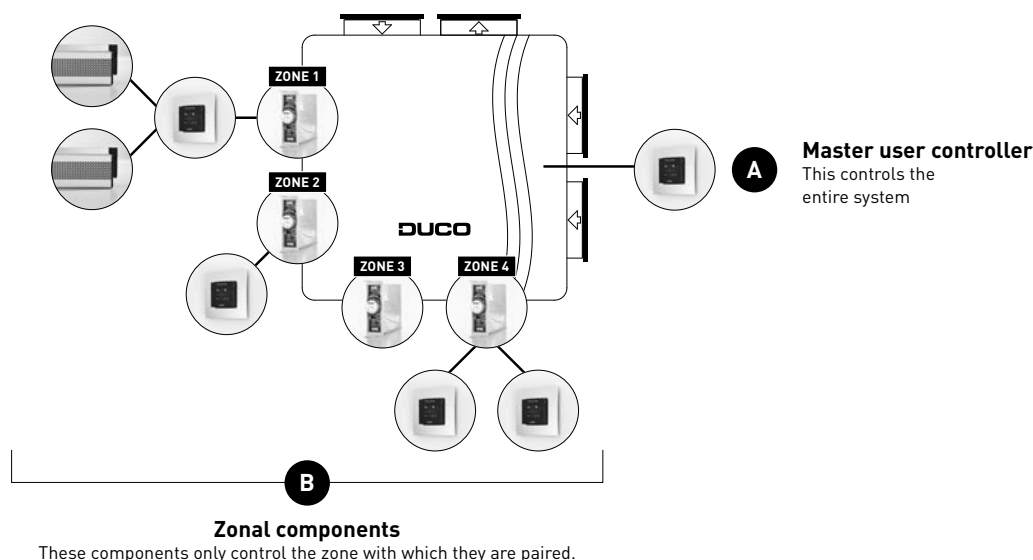

It is important that components are paired with the correct zone for this zonal operation. Components can be paired with the DucoBox Focus itself (controlling **all zones**) or with a control valve (controlling **a single zone**). A component will be paired in every case with the component (control valve or DucoBox) that is flashing rapidly. It is possible to pair several user controllers in one zone, but not to link one user controller to multiple control valves or DucoBoxes.



Never pair more than one system with RF components at the same time. If you do so, a component could be paired in the wrong network, (e.g. in the neighbours' DucoBox) or the component may not want to pair.



With RF components it is recommended to start with the component closest to the DucoBox. This enables this component to be used as a hop for components that are too distant from the DucoBox and unable to make a direct RF connection with the DucoBox.

## Pairing components

- 1 Activate 'Installer mode' by tapping **'INST'** on the DucoBox. The LED will flash green rapidly.
- 2 **Pairing components on the DucoBox:**  
Use this method for any components that are required to control the **entire system** (e.g. a master user controller).
  - 2a Tap **on the button of the component to be paired once** while the LED on the DucoBox is flashing rapidly. The LED on this component will flash red briefly and then start to flash green rapidly.
- 3 **Pairing components with a control valve:**  
Use this method for components that only control the **zone** connected to the control valve duct. Repeat these steps for each zone.
  - 3a **Tap the control valve once** so the LED starts to flash green rapidly. Underlying components can now be added in this zone.
  - 3b Add **control components** by tapping once on the component to be paired. The LED will flash red briefly and then start to flash green rapidly.
  - 3c Add any **window ventilators** by tapping once on the component to be paired. The LED will flash green slowly.
- 4 Once all components have been paired, 'Installer mode' can be deactivated by tapping **'INST'** on the DucoBox Focus. The LEDs on all components will stop flashing.

Please refer to the manual with the components for more detailed information.

## 06.D Removing / replacing components

Removing paired components from the network or replacing is **only possible within 30 minutes after the component is paired in or is restarted**. Restarting can be done by disconnecting the power for a moment. After a time-span of 30 minutes, remove and replace operations are ignored. This is valid for **all components from date of manufacture 170323**.

### Removing a component

- 1 Activate 'Installer mode' by **long-pressing 2 diagonal buttons on a paired control**. The LED will flash green or yellow rapidly.

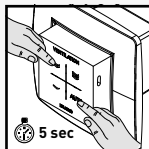

- 2 Press **once and hold** a button on the component to be removed in order to remove it from the network. **ATTENTION: any underlying components will also be removed from the network.**

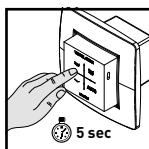

- 3 Deactivate 'Installer mode' by pressing the 4 buttons on a **paired control** simultaneously (or using the palm of your hand on a control featuring touch buttons). The LED will turn white.

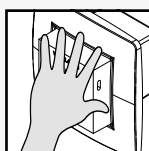

### Replacing a component

- 1 Activate 'Installer mode' by **long-pressing 2 diagonal buttons on a paired control**. The LED will flash green or yellow rapidly.

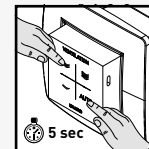

- 2 Briefly press **twice** on the button of the component to be replaced.

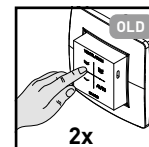

- 3 **Tap once** on the button of the new component. The latter will take on all settings / connections in the network.

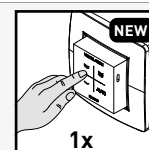

- 3 Deactivate 'Installer mode' by pressing the 4 buttons on a **paired control** simultaneously (or using the palm of your hand on a control featuring touch buttons). The LED will turn white.

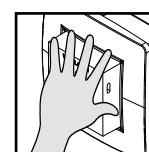

## 06.E Tips

- **Removing all components from the network (e.g. in the event of problems):** Activate 'Installer mode' and long-press 'INST' until the LED starts flashing red. The DucoBox will reboot and the LED will stop flashing.
- **Restoring factory settings for the DucoBox and all paired components (AS FROM DucoBox version 18xxxx):** Long-press 'INST' and 'ENTER' if not in 'Installer mode'. The network remains in place.
- Use the **Duco Installation App** or the **Duco Network Tool** to read out information from components.

# 07 Flow rate calibration

For the system to work correctly, it needs to be configured. This will ensure its operation is as quiet as possible and energy-efficient. For information on determining the ventilation flow rates, see Instruction Sheet Checking Product References and Flow Rates at [www.duco.eu](http://www.duco.eu).

## 07.A Air calibration procedure for DucoBox Focus



**The air calibration procedure must be carried out on a calm day** (no more than wind force 2: leaves rustling, feeling the wind in one's face).

### DucoBox Focus air calibration

1

The exhaust vents must be set depending on the situation. Proper pre-setting makes for rapid and correct configuration.

#### SITUATION 1: one vent per valve

Set **all vents to the fully open position**, regardless of the desired flow rate.

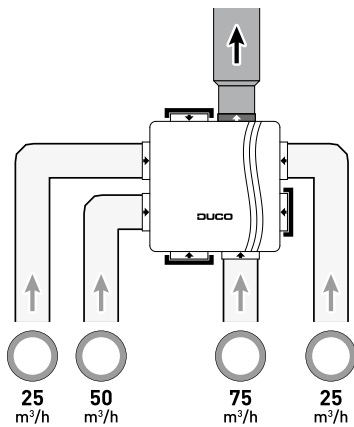

#### SITUATION 2: Multiple vents per valve with equal flow rates

Set **all vents to the fully open position**, regardless of the desired flow rate. Set the valve to the sum of the vent flow rates via the display menu or the Duco Network Tool. Example: 2 vents, 50 m<sup>3</sup>/h each → set valve to 100 m<sup>3</sup>/h.

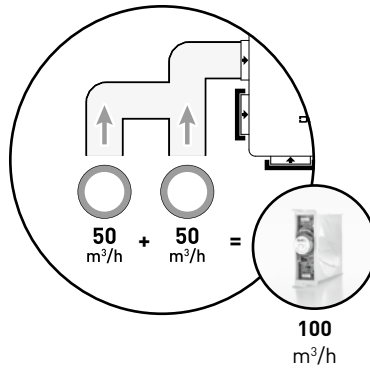

#### SITUATION 3: Multiple vents per valve with different flow rates

Set the exhaust vents so they match the desired flow rate **in line with the table below**. Set the valve to the sum of the vent flow rates via the display menu or the Duco Network Tool. Example: 25 m<sup>3</sup>/h vent and 75 m<sup>3</sup>/h vent → set valve to 100 m<sup>3</sup>/h.

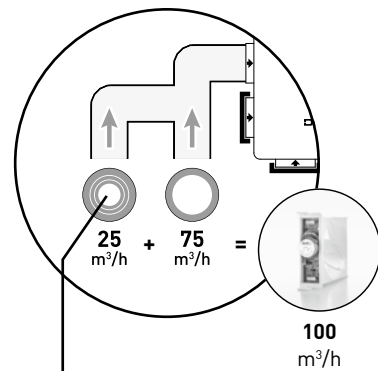

When using DucoVent Design exhaust vents always leave the outer ring in place for acoustic effect.

| Flow rate           | DucoVent Design | DucoVent Basic and other vents |
|---------------------|-----------------|--------------------------------|
| 75m <sup>3</sup> /h |                 | 100% open                      |
| 50m <sup>3</sup> /h |                 | 50% open                       |
| 25m <sup>3</sup> /h |                 | 25% open                       |

Before activating air calibration mode:

- Close **all** windows and doors.
- Ensure that **all duct openings in the DucoBox are fully closed and that the DucoBox cover is closed!**
- Avoid air leaks in the ventilation ducts.
- Set all window ventilators to the open position. Any Tronic ventilators will open automatically.

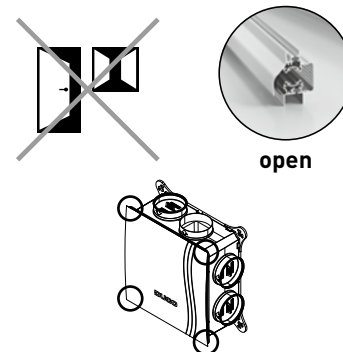

2

3 Pull the plug out of the socket and wait a few seconds.

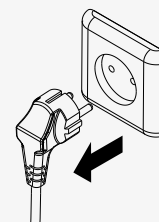

4

Put the plug back into the socket. The DucoBox will be configured automatically on start-up. Calibration takes 30 seconds + 1 minute per connected control valve.

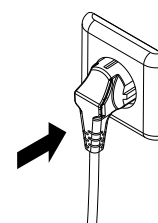

## 07.B Checking

The steps set out below can be used to check whether flow rates have been set correctly.

### Checking configured flow rate

- 1 Open the lid of the DucoBox.
- 2 Press 'HIGH' briefly. The DucoBox will remain in configuration mode for 30 minutes (as standard).
- 3 Close the lid.
- 4 Wait at least one minute to allow the ventilation system to stabilise.
- 5 Measure the vents. If a flow rate differs from the desired output, this can be adjusted via the display menu or using the Duco Network Tool.
- 6 If you finish before the standard setting of 30 minutes, re-open the DucoBox lid and press 'HIGH' again. Then replace the lid on the DucoBox.

## 08 Maintenance & service

Please refer to the maintenance instructions at [www.duco.eu](http://www.duco.eu) and view the videos on [duco.tv](http://duco.tv) for more information.

### For service problems as a user:

Please contact your installer. Keep the serial number of your product to hand.

### For service problems as an installer:

Please contact your Duco products seller. Keep the serial number of your product to hand.



Sticker inside the DucoBox

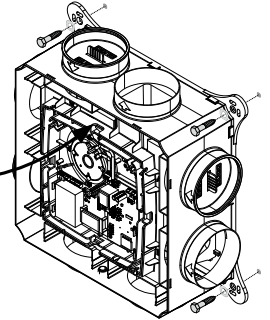

## 09 Warranty

All warranty conditions concerning the DucoBox and Duco's ventilation systems can be found on the DUCO website.

All complaints are to be reported to Duco by the Duco distributor with a clear description and the order/invoice number under which the products were delivered. In order to register the complaint, please use the complaint registration form found on the Duco website and the product's serial number in your message to [service@duco.eu](mailto:service@duco.eu).

# 10 Legislation

Product card, EC declaration of conformity and energy labels can be viewed and downloaded at [www.duco.eu](http://www.duco.eu).

Installed by:

**DUCO**